



Europe on your roof!

European clay roof tiles that will last for generations...

The roof tile **Actua10** is a
feast for lovers of
modern architecture



10.5
tiles/sqmtr

ACTUA 10 Germany

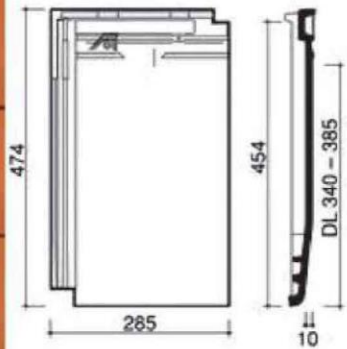
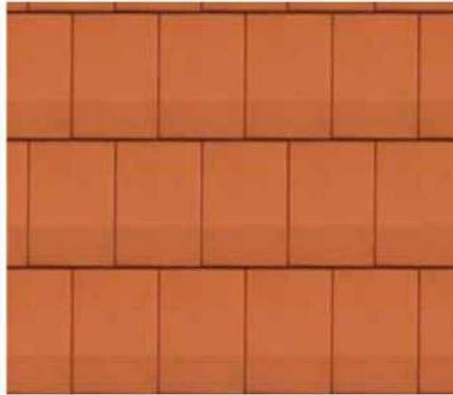

Technical Information

Dimensions	474mm x 285 mm
Tiles per Sqmtr	10.5 no's
Batten Spacing	342-385mm
Weight pertile	4.5 kg
Minimum roof pitch	25 degree



75 mm variable Spacing

- Crisp, clean lines of modern architecture.
- Simple division by large sliding roof area
- Modern color spectrum
- Variable batten spacing



Natural Red

Red Engobe

Noble Clinker Red

Grey

Black Matt

Noble Black

Noble Graphite

Madura

A large format
contemporary
wave profile



11.3
tiles/sqmr

Madura Netherland

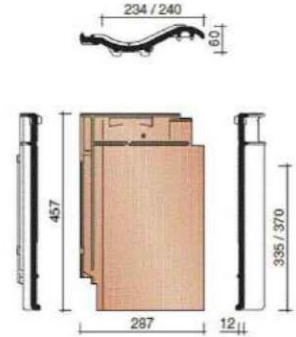
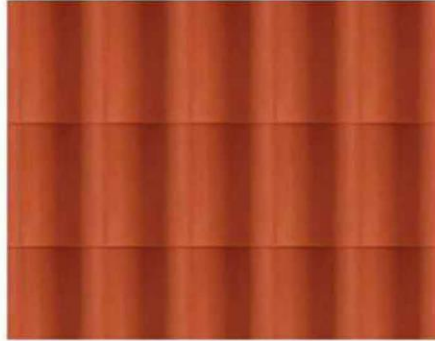

Technical Information

Dimensions	457 mm x 287 mm
Tiles per sqmtr	11.3
Batten spacing	335-370 mm
Weight per tile	3.8 kg
Minimum roof pitch	18 degree

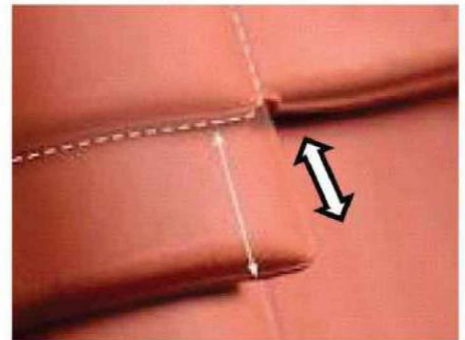

35 mm variable spacing

- An aesthetic curve tile which fulfills the functionality of a complete roof.
- This pan gives the roof a wavy appearance.
- Double groove & Variable batten spacing.



Natural Red



Autum Satiny



Slate Engobe



Noble Black Engobe



Black Glazed

Alegra10

combines economy
and aesthetics in an
optimal way.



10.6
tiles/sqmtr

Alegra 10

Germany

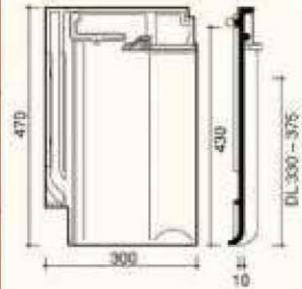

Technical Information

Dimensions	470 mm x 300 mm
Tiles per sqmtr	10.6
Batten spacing	330-375 mm
Weight per tile	4.2 kg
Minimum roof pitch	18 degree



45 mm variable spacing

- Top edge of large displacement range from 330 mm to 375 mm.
- Simple division into the roof renovation and new construction.
- Variable batten spacing.



Natural Red



Red Engobe



Copper Brown



Noble Grey



Noble Chestnut



Platinum Grey

Romane

Combining strong curve and technical performance, it's a tile that renders a Mediterranean touch

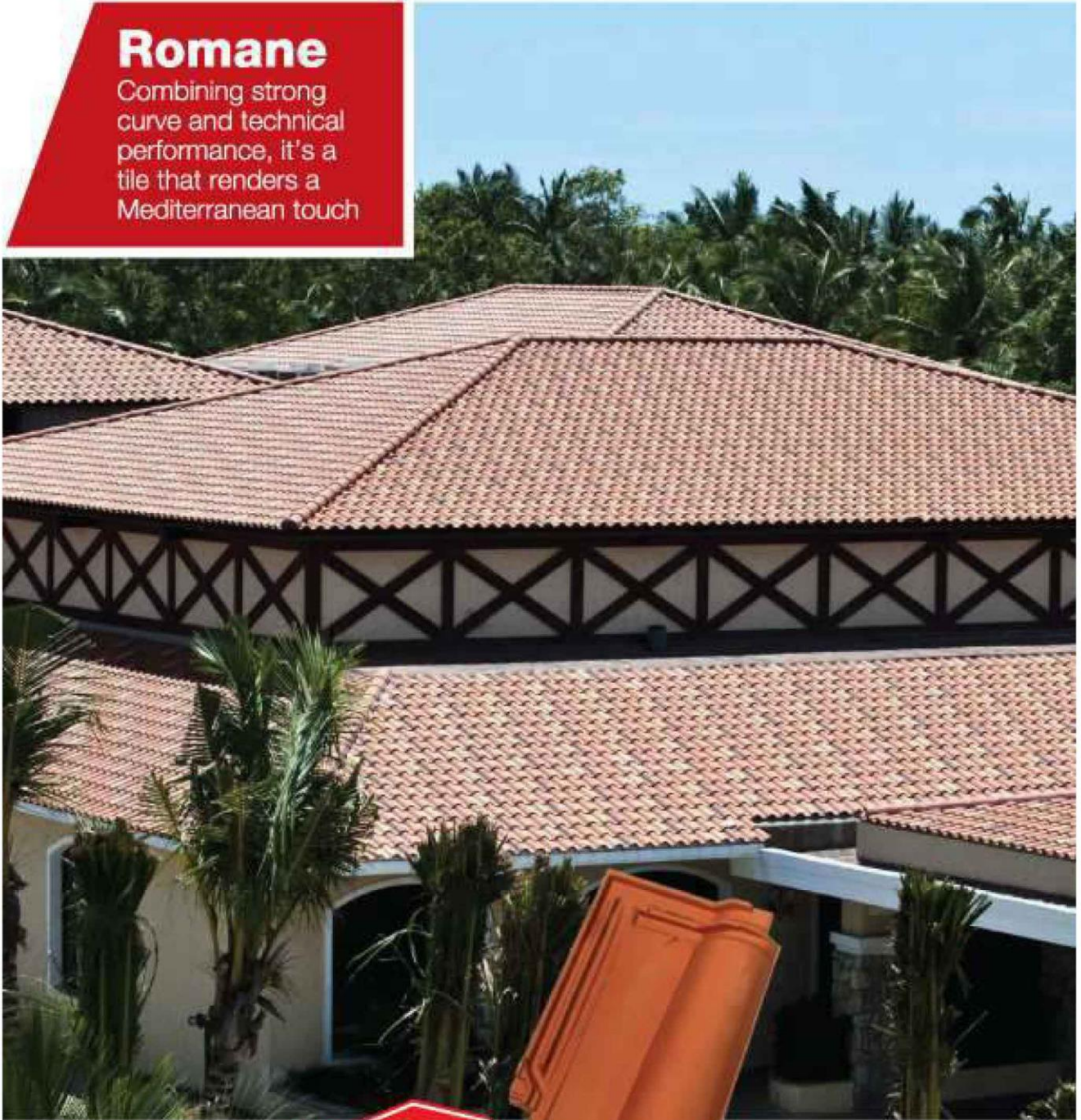

11.5
tiles/sqmtr

Romane France

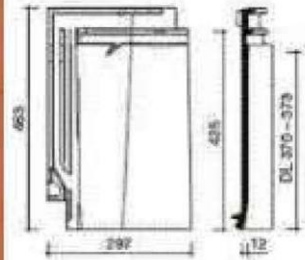

Technical Information

Dimensions	463 mm x 297 mm
Tiles per sqmtr	11.5
Batten spacing	372 mm
Weight per tile	3.9 kg
Minimum roof pitch	25 degree



- Optimum water flow through the longitudinal design.
- Double groove and head interlocking joints.
- Special finishes antique & old ochre.



Natural Red



Multi Blend



Antique



Straw



Old Ocre

VHV

Flemish Tile with
a curve, which
merges into
a harmonic wave



15.1
tiles/sqmtr

VHV Netherland

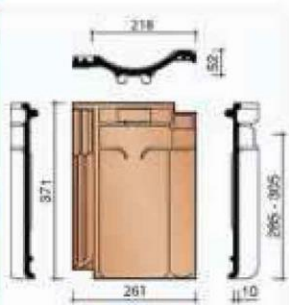

Technical Information	
Dimensions	371 mm x 261 mm
Tiles per Sqmtr	15.1
Batten Spacing	285-305 mm
Weight per tile	2.6 kg
Minimum roof pitch	25 degree



30 mm variable spacing

- Various finishes available like Natural, Weathered, Glazed and engobed.
- Ideal size to fit into various parts of the roof.
- Variable spacing and interlock for water tightness.



Rustic

Weather Red

Black Glazed

Light Brown Glazed

Slate Matt Glazed

MODULA

A specialised large format modular ceramic tile with both aesthetic & functional qualities

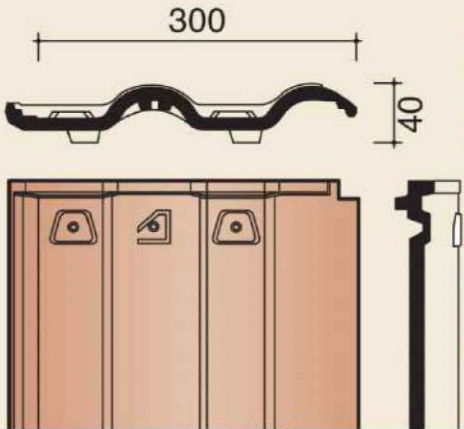

9
tiles/sqmt

MODULA NETHERLANDS

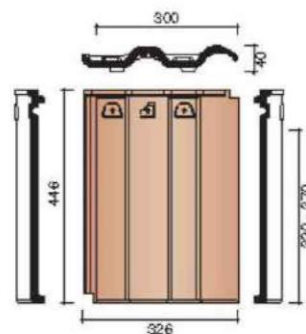
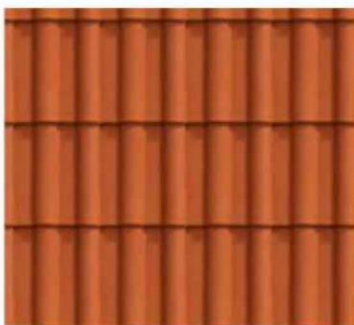

Technical Information

Dimensions	446 mm x 326 mm
Tiles per sq mt	9 – 10.4 no's
Batten Spacing	320 - 370 mm
Weight per tile	3.99 Kg
Minimum roof pitch	25 degree



- An innovative design with double Romane
- A New Generation Clay Tile with design philosophy
- Built upon the desire to combine high performance with ease and speed of tiles laying
- Has a working width of 30 cms



Natural Red



Multiblend



Slate Engobe



Noble Black
Glazed



Prima

Contemporary tile with sharp angles

Prima

Combining the beauty of Terracotta with contemporary design statement



Technical Information	
Length x Width	474 x 316 mm
Batten Spacing	340 - 380 mm
Effective Cover Width	275 mm
Quantity in per m ²	9.5
Weight of the Tile	± 4.4 kg

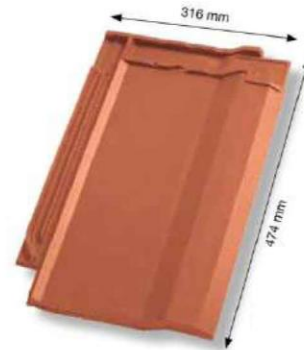

- A very contemporary look, lending a futuristic character
- With every sharp angle creating an interesting play of light
- Known for its very economical large size and ease of implementation
- Suitable for low slopes, smooth and deep finish due to interlocking surface & plaster molds.



Rouge

Nuagé

Ardoisé

Multi-Blend Colour

The naturalness of terracotta products necessarily induces the possibility of nuanced hues. It is therefore recommended to mix several pallets at the time of installation.



Opalys

Wide format Roof Tile
with 2 in 1
(Double Roof) effect

Opalys

The first of it's kind
Wide Format Roof Tile

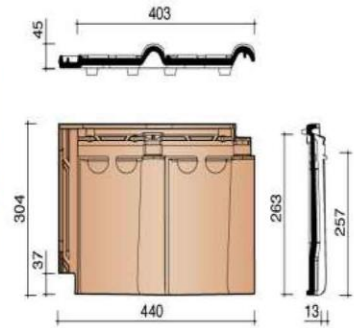

Technical Information	
Tile Width	403 mm
Total Average Length	304 mm
Total Average Width	440 mm
Quantity in per m ²	9.5
Weight of the Tile	± 3.5 kg



- The soft wave like feature of the tile lends a special look to the roof
- Available in 3 colours
- Double interlocking, double recovery
- Reconciles economic, aesthetic, simplicity, and speed of installation



Nuagé



Anthracite



Aubergine



Wienerberger:

World leader in building material solutions

Founded in 1819, Wienerberger has been providing wall solutions, roof solutions, facade solutions, pavers and landscaping solutions for over 200 years now.

It's the legacy of a brand whose iconic flame has been the beacon for beauty and innovation in building. A profound respect for the environment in which we live drives our innovation, processes and our products, manufactured in around 226 plants in 30 countries.

In India, we've set up our factory at Kunigal, near Bangalore. Worldwide, we've made a reputation as:

- The experts that building professionals trust
- Enablers of building with a clear conscience
- Providers of energy-efficient and sustainable building materials



Wienerberger India Private Limited

88/4, Richmond Road, Bangalore - 560 025, Karnataka.

Tel: +91 80 4149 1682-7, Email: marketing@wienerberger.in

Website: www.wienerberger.in